

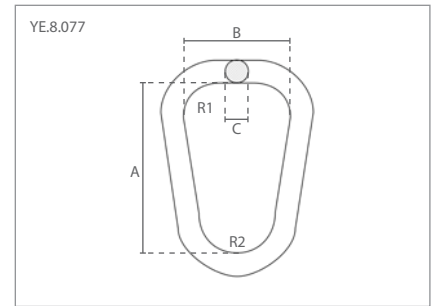

Grade 80 Toebehoren volgens EN 1677 / Grade 80 Accessories according to EN 1677

1. Topschalmen / Master links
2. Topschalmen met verloopringen / Master link assemblies
3. Kraanschalmen / Crane links

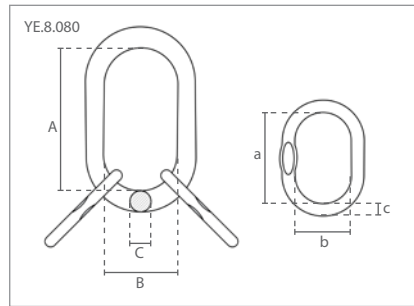
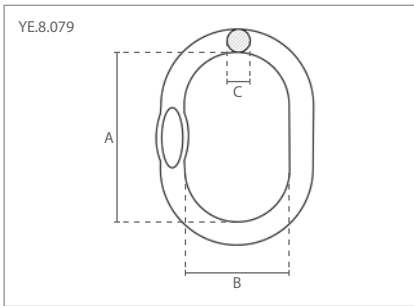

1 Specificaties / Specifications				Afmetingen / Dimensions (mm)		
Artikel nummer	Capaciteit / Capacity	Gewicht / Weight	Markering	A	B	C
Article code	ton	kg	Marking			
YE.8.079.07-06	1.60	0.4	G8 079-06	110	60	13
YE.8.079.08-07	2.12	0.6	G8 079-08	110	60	16
YE.8.079.10-08	3.15	0.8	G8 079-10	135	75	18
YE.8.079.13-10	5.30	1.5	G8 079-13	160	90	22
YE.8.079.16-13	8.00	2.3	G8 079-16	180	100	26
YE.8.079.18-16	11.20	4.0	G8 079-18	200	110	32
YE.8.079.20-18	14.00	6.4	G8 079-20	260	140	36
YE.8.079.22-20	17.00	9.0	G8 079-22	300	160	40
YE.8.079.26-22	21.20	12.8	G8 079-26	340	180	45
YE.8.079.32-26	31.50	16.6	G8 079-32	350	190	50
YE.8.079.36-32	45.00	23.3	G8 079-36	400	200	56
YE.8.079.40-36	56.00	32.0	G8 079-40	430	220	63
YE.8.079.72	63.00	45.8	G8 079-72	460	250	72

2 Specificaties / Specifications				Afmetingen / Dimensions (mm)					
Artikel nummer	Capaciteit / Capacity	Gewicht / Weight	Markering	A	B	C	a	b	c
Article code	ton	kg	Marking						
YE.8.080.07	3.15	1.3	G8 080-06	135	75	18	60	38	13
YE.8.080.08	4.25	2.2	G8 080-08	160	90	22	70	34	16
YE.8.080.10	6.70	3.4	G8 080-10	180	100	26	85	40	18
YE.8.080.13	11.20	6.1	G8 080-13	200	110	32	115	50	22
YE.8.080.16	17.00	10.0	G8 080-16	260	140	36	140	65	26
YE.8.080.20	26.50	22.6	G8 080-20	350	190	50	180	100	32
YE.8.080.22	31.50	25.2	G8 080-22	350	190	50	180	100	36
YE.8.080.26	45.00	34.6	G8 080-26	400	200	56	180	100	40
YE.8.080.32	63.00	66.5	G8 080-32	460	250	72	200	110	50

3 Specificaties / Specifications				Afmetingen / Dimensions (mm)					
Artikel nummer	Capaciteit / Capacity	Gewicht / Weight	Markering	A	B	C	R1	R2	
Article code	ton	kg	Marking						
YE.8.077.22.04	4.00	2.2	G8 077-22	240	150	22	45	50	
YE.8.077.25.05	5.00	2.8	G8 077-25	280	175	25	52	60	
YE.8.077.32.08	8.00	5.4	G8 077-328	320	215	32	70	70	
YE.8.077.32.09	9.00	7.8	G8 077-329	280	175	32	52	60	
YE.8.077.38.15	15.00	6.2	G8 077-38	280	175	38	52	60	
YE.8.077.45.20	20.00	12.7	G8 077-45	320	215	45	70	70	